



U.S. Department
of Transportation

Pipeline and
Hazardous Materials
Safety Administration

IAEA CERTIFICATE OF COMPETENT AUTHORITY
SPECIAL FORM RADIOACTIVE MATERIALS
CERTIFICATE USA/0608/S-96, REVISION 3

East Building, PHH-23
1200 New Jersey Avenue SE
Washington, D.C. 20590

This certifies that the sources described have been demonstrated to meet the regulatory requirements for special form radioactive material as prescribed in the regulations of the International Atomic Energy Agency¹ and the United States of America² for the transport of radioactive material.

1. Source Identification - Source Production and Equipment Company Series B, G, R, and T Model Sources manufactured after November 30, 2002.
2. Source Description - Either single or double encapsulations constructed of Type 316L stainless steel and tungsten-inert-gas welded. Approximate outer dimensions of the single encapsulation capsules are 3.94 mm (0.155 in.) to 6.86 mm (0.270 in.) in diameter and a maximum length of 25.4 mm (1.00 in.). Approximate outer dimensions of the double encapsulation capsules are 6.35 mm (0.250 in.) in diameter and a maximum length, not including the cable attachment cavity, of 28.7 mm (1.130 in.). Construction shall be in accordance with attached Source Production and Equipment Company Drawing Nos. B920012, Rev. 1, Sheet 1 of 1; or B920008, Rev. 1, Sheet 2 of 2.
3. Radioactive Contents - No more than 11.1 TBq (300 Ci) of either Selenium-75, Ytterbium-169, or Iridium-192. The Ir-192 activity cited is output activity, as defined in ANSI Standard N432-1981. The Se-75 is in solid elementary form. The Yb-169 is in the form of a solid metal oxide. The Ir-192 is in the form of metal pellets.
4. Quality Assurance - Records of Quality Assurance activities required by Paragraph 310 of the IAEA regulations¹ shall be maintained and made available to the authorized officials for at least three years after the last shipment authorized by this certificate. Consignors in the United States exporting shipments under this certificate shall satisfy the applicable requirements of Subpart H of 10 CFR 71.
5. Expiration Date - This certificate expires on April 30, 2012. On November 30, 2008, this certificate supersedes all previous revisions of USA/0608/S-96.

¹ "Regulations for the Safe Transport of Radioactive Material, 1996 Edition (Revised), No. TS-R-1 (ST-1, Revised)," published by the International Atomic Energy Agency (IAEA), Vienna, Austria.

² Title 49, Code of Federal Regulations, Parts 100-199, United States of America.

CERTIFICATE USA/0608/S-96, REVISION 3

This certificate is issued in accordance with paragraph 804 of the IAEA Regulations and Section 173.476 of Title 49 of the Code of Federal Regulations, in response to the August 15, 2008 petition by Source Production and Equipment Company, St. Rose, LA, and in consideration of other information on file in this Office.

Certified By:

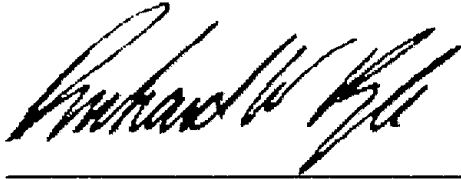

 Robert A. Richard
Deputy Associate Administrator for Hazardous Materials Safety

Sep 03 2008
(DATE)

Revision 3 - Issued to revise the authorized minimum diameter of the single encapsulation capsule.

CONTROLLED COPY NO

REVISIONS		
REV	DESCRIPTION	DATE
(1)	INCORPORATED CRF 000231	8-7-08 8-10-08 8-15-08
		APPROVED KR KR KR

NOTES:

- 1. FUSION WELDING (GTAW TIG).
- 2. EXTERNAL THREADS MAY BE ADDED.

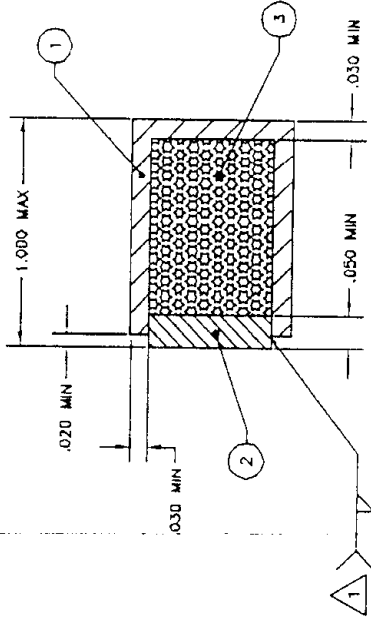
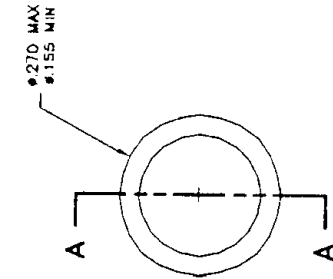

SECTION A-A

AR	CI	DESCRIPTION	QTY	UNIT	TER	REF
1	EA	IRIDIUM 192				3
1	EA	SOLID METALLIC PELLETS				
		240 CT MAX OUTPUT				
		316L				
1	EA	CAPSULE CAP				2
1	EA	CAPSULE				1
		316L				
		316L				
		STAINLESS STEEL				
		STAINLESS STEEL				
		316L				
		316L				
		STAINLESS STEEL				
		STAINLESS STEEL				
		316L				
		316L				
		STAINLESS STEEL				
		STAINLESS STEEL				
		316L				
		316L				
		STAINLESS STEEL				
		STAINLESS STEEL				
		316L				
		316L				
		STAINLESS STEEL				
		STAINLESS STEEL				
		316L				
		316L				
		STAINLESS STEEL				
		STAINLESS STEEL				
		316L				
		316L				
		STAINLESS STEEL				
		STAINLESS STEEL				
		316L				
		316L				
		STAINLESS STEEL				
		STAINLESS STEEL				
		316L				
		316L				
		STAINLESS STEEL				
		STAINLESS STEEL				
		316L				
		316L				
		STAINLESS STEEL				
		STAINLESS STEEL				
		316L				
		316L				
		STAINLESS STEEL				
		STAINLESS STEEL				
		316L				
		316L				
		STAINLESS STEEL				
		STAINLESS STEEL				
		316L				
		316L				
		STAINLESS STEEL				
		STAINLESS STEEL				
		316L				
		316L				
		STAINLESS STEEL				
		STAINLESS STEEL				
		316L				
		316L				
		STAINLESS STEEL				
		STAINLESS STEEL				
		316L				
		316L				
		STAINLESS STEEL				
		STAINLESS STEEL				
		316L				
		316L				
		STAINLESS STEEL				
		STAINLESS STEEL				
		316L				
		316L				
		STAINLESS STEEL				
		STAINLESS STEEL				
		316L				
		316L				
		STAINLESS STEEL				
		STAINLESS STEEL				
		316L				
		316L				
		STAINLESS STEEL				
		STAINLESS STEEL				
		316L				
		316L				
		STAINLESS STEEL				
		STAINLESS STEEL				
		316L				
		316L				
		STAINLESS STEEL				
		STAINLESS STEEL				
		316L				
		316L				
		STAINLESS STEEL				
		STAINLESS STEEL				
		316L				
		316L				
		STAINLESS STEEL				
		STAINLESS STEEL				
		316L				
		316L				
		STAINLESS STEEL				
		STAINLESS STEEL				
		316L				
		316L				
		STAINLESS STEEL				
		STAINLESS STEEL				
		316L				
		316L				
		STAINLESS STEEL				
		STAINLESS STEEL				
		316L				
		316L				
		STAINLESS STEEL				
		STAINLESS STEEL				
		316L				
		316L				
		STAINLESS STEEL				
		STAINLESS STEEL				
		316L				
		316L				
		STAINLESS STEEL				
		STAINLESS STEEL				
		316L				
		316L				
		STAINLESS STEEL				
		STAINLESS STEEL				
		316L				
		316L				
		STAINLESS STEEL				
		STAINLESS STEEL				
		316L				
		316L				
		STAINLESS STEEL				
		STAINLESS STEEL				
		316L				
		316L				
		STAINLESS STEEL				
		STAINLESS STEEL				
		316L				
		316L				
		STAINLESS STEEL				
		STAINLESS STEEL				
		316L				
		316L				
		STAINLESS STEEL				
		STAINLESS STEEL				
		316L				
		316L				
		STAINLESS STEEL				
		STAINLESS STEEL				
		316L				
		316L				
		STAINLESS STEEL				
		STAINLESS STEEL				
		316L				
		316L				
		STAINLESS STEEL				
		STAINLESS STEEL				
		316L				
		316L				
		STAINLESS STEEL				
		STAINLESS STEEL				
		316L				
		316L				
		STAINLESS STEEL				
		STAINLESS STEEL				
		316L				
		316L				
		STAINLESS STEEL				
		STAINLESS STEEL				
		316L				
		316L				
		STAINLESS STEEL				
		STAINLESS STEEL				
		316L				
		316L				
		STAINLESS STEEL				
		STAINLESS STEEL				
		316L				
		316L				
		STAINLESS STEEL				
		STAINLESS STEEL				
		316L				
		316L				
		STAINLESS STEEL				
		STAINLESS STEEL				
		316L				
		316L				
		STAINLESS STEEL				
		STAINLESS STEEL				
		316L				
		316L				
		STAINLESS STEEL				
		STAINLESS STEEL				
		316L				
		316L				
		STAINLESS STEEL				
		STAINLESS STEEL				
		316L				
		316L				
		STAINLESS STEEL				
		STAINLESS STEEL				
		316L				
		316L				
		STAINLESS STEEL				
		STAINLESS STEEL				
		316L				
		316L				
		STAINLESS STEEL				
		STAINLESS STEEL				
		316L				
		316L				
		STAINLESS STEEL				
		STAINLESS STEEL				
		316L				
		316L				
		STAINLESS STEEL				
		STAINLESS STEEL				
		316L				
		316L				
		STAINLESS STEEL				
		STAINLESS STEEL				
		316L				
		316L				
		STAINLESS STEEL				
		STAINLESS STEEL				
		316L				
		316L				
		STAINLESS STEEL				
		STAINLESS STEEL				
		316L				
		316L				
		STAINLESS STEEL				
		STAINLESS STEEL				
		316L				
		316L				
		STAINLESS STEEL				
		STAINLESS STEEL				
		316L				
		316L				
		STAINLESS STEEL				
		STAINLESS STE				

CONTROLLED COPY NO.	
REV	APPROVED
DESCRIPTION	DATE

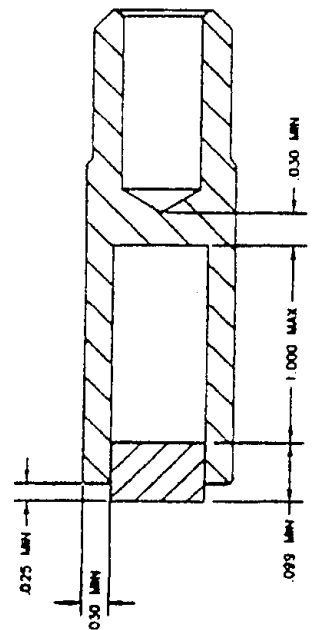

SECTION A-A

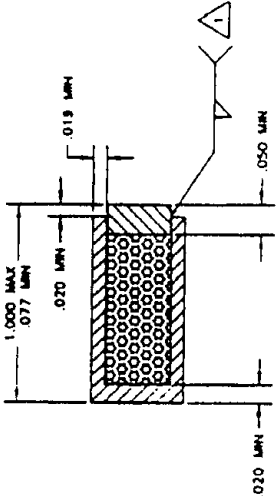

SECTION B-B

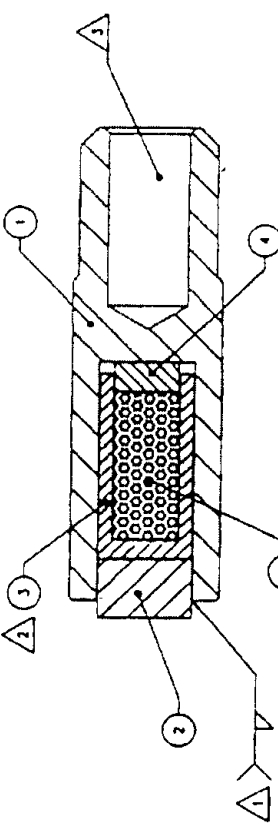

SECTION C-C

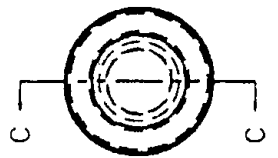
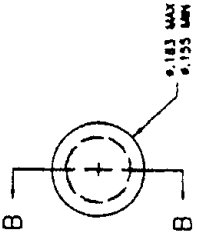
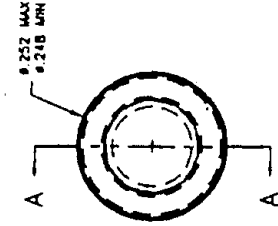

REV	APPROVED
DESCRIPTION	DATE
SCALE: 8/1	
N 00113501 SHEET 2 OF 2	
C B920008	